

WORCESTER GREENSTORE

Indirect Unvented Cylinder with Solar Coil

FOR USE WITH WORCESTER GREENSTORE SYSTEM HEATPUMP ONLY



GB/IE

WORCESTER GREENSTORE 180 CYLINDER
SOLAR COMPATIBLE

WORCESTER GREENSTORE 280 CYLINDER
SOLAR COMPATIBLE

Instruction Manual
Installation Commissioning
& Servicing



 **WORCESTER**
Bosch Group

The Greenstore cylinder shell is made from Stainless Steel for excellent corrosion resistance. Greenstore cylinders have a strong steel case and are well insulated with environmentally friendly insulation. They are available in two sizes, 180 and 280 litres, both with a supplementary coil for use with solar or other fuels. For other fuels, you may need to source a dual thermostat for control purposes.

The Greenstore cylinder is supplied complete with all the necessary, pre-adjusted, safety and control devices needed to connect to the cold water supply mains. High quality controls have been selected to combine high flow rate performance with minimum pressure drop to allow the Greenstore cylinder to perform well in areas, where there is a minimum dynamic working mains pressure of 1.5 bar. Greenstore cylinders are KIWA approved and comply with Building Regulations KIWA sections G3 and Part L1.

STORAGE PRIOR TO INSTALLATION

The Greenstore cylinder should be stored upright in the original packaging and in an area free from excessive moisture.

IMPORTANT NOTE TO THE INSTALLER

Read these installation and maintenance instructions carefully before commencing work. Unvented cylinders are a controlled service as defined in the latest edition of the building regulations and must only be fitted by a qualified person.

The relevant regulations are: England and Wales - Building Regulations G3,
Scotland - Technical standard P3,
Northern Ireland - Building Regulation P5

After installation, the benchmark log, in the back of this manual, must be completed and left along with these instructions with the householder for future reference.

Expansion Vessel



Expansion Vessel Hose



Wall Mounting Bracket for Expansion Vessel



High Flow Rate Inlet Control Set



UNPACKING THE UNIT

Greenstore cylinders come complete with all the fittings required to complete the installation:

- Inlet Control set
- 15mm / 22mm Acetal Tundish
- Expansion vessel
- Wall mounting bracket
- Expansion vessel hose
- Thermostat for second energy input. (1 x manual reset - high limit stat for solar)
- Installation & Maintenance Instructions
- Hot water sensor GT3 (Supplied with cylinder)

Acetal Tundish



Installation & Maintenance Instructions

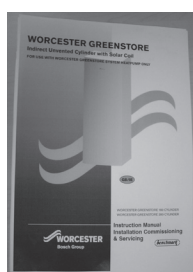

Solar High Limit Stat

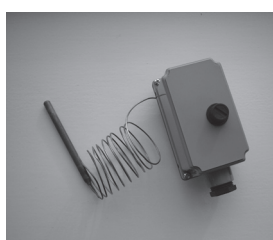

WATER SUPPLY

The Worcester Greenstore cylinder has an optimum working pressure of 3 bar (regulated by the inlet control set) and is capable of delivering upto 50 litres per minute.

The maximum possible water demand should be assessed taking into consideration that both hot and cold services are supplied simultaneously from the mains.

The water supply should be checked to ensure it can meet these requirements. If necessary consult the local water authority regarding the likely pressure and flow rate availability.

If measuring the water pressure note that a high static (no flow) mains pressure is no guarantee of good flow availability. In a domestic installation 1.5 bar and 25 l/m should be regarded as the minimum requirement. The maximum mains pressure for the inlet control is 16 bar.

Consideration should be given to upgrading existing 1/2" (15mm) cold mains pipework to a larger size if the recommended minimum pressure/flowrate is not being achieved.

SITING THE UNIT

Outlets that are above or at some distance from the Greenstore cylinder, can still be supplied with water.

Outlets above the Greenstore cylinder will reduce the outlet pressure available by 0.1 bar for every 1 metre of height difference.

Site the unit to minimise "dead leg" distances especially to the point of most frequent use.

The unit should be protected from frost. Particular care is needed if siting in a garage or outbuilding. All exposed pipework must be insulated.

Greenstore cylinders must be installed upright on a flat base capable of supporting the weight of the cylinder when full of water (see technical specification section for weights).

The discharge pipework from the safety valves should fall continuously and terminate safely.

Notes:

The pressure reducing valve, non return valve and expansion relief valve are combined together in the inlet control set.

Consideration should be given for servicing and repair, when siting the cylinder.

The cylinder position should be taken into consideration when siting the Heat Pump.

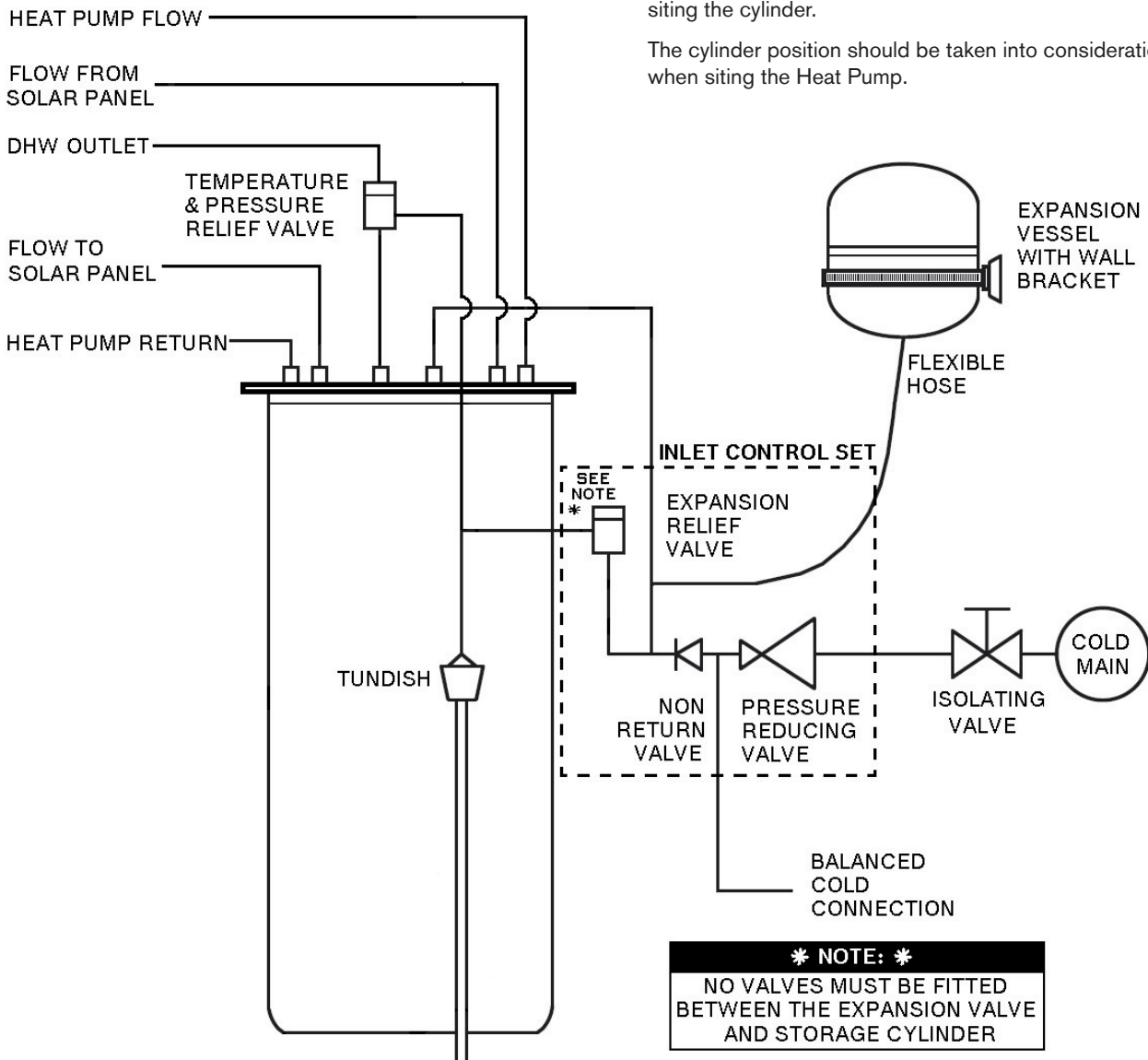

GENERAL INSTALLATION

COLD MAINS PIPEWORK

Run the cold main through the building to where the Greenstore cylinder is to be installed. Take care not to run the cold pipe near hot water or heating pipe work to minimize heat pick up. Identify the cold water supply pipe and fit an isolating valve (not supplied)

A 22mm BS1010 stopcock can typically be used but a 22mm quarter turn full bore valve is preferred as it does not restrict the flow as much. Do not use "screwdriver slot" or similar valves.

Position the inlet control just ABOVE the Temperature & Pressure Relief Valve (TPRV) mounted on the top of the cylinder. This ensures that the cylinder does not have to be drained down in order to service the inlet control set.

Check that the arrow points in the direction of the water flow.

Mount the expansion vessel in a suitable position on the wall using the bracket provided. Use the hose to connect to the inlet control group.

Ensure that the top of the vessel is accessible for servicing.

BALANCED COLD CONNECTION

Where there are showers, bidets or monobloc taps in the installation then a balanced cold supply is necessary. There is a 22mm balanced connection on the inlet control set. Another method is to split the inlet control set on to two parts. Site the pressure reducing valve immediately after the incoming cold mains stopcock (typically under the kitchen sink.) All outlets in the house will be at 3 bar and thus automatically balanced. The expansion relief valve section must still be mounted just above the TPRV on the cylinder. A 3/4" F-22mm compression adaptor will be needed (not supplied)

HOT WATER PIPEWORK

Run the first part of the hot water distribution pipework in 22mm. This can be reduced to 15mm and 10mm as appropriate for the type of tap etc. Your aim should be to reduce the volume of the hot draw-off pipework to a practical minimum so that the time taken for the hot water is as quick as possible.

Do not use monobloc mixer taps or showers if the balanced cold connection is not used. The unit will back pressurize the cylinder and result in discharge.

PRIMARY COIL CONNECTIONS

Connect the primary connections (Indirect only) using the compression fittings provided for connection to the Worcester Heat Pump only.

It is preferred that the primary circuit is a sealed system with a maximum pressure of 2.5 bar. An additional expansion vessel and safety valve would be required in this case.

The supplementary coil is for use with Worcester Solar Systems exclusively that are equipped with Worcester solar controls. Please refer to the installation manuals, Greenstore System Installation manual and Worcester Greenskies Solar literature:

NOTE:

The relief valve connection should not be used for any other purposes.

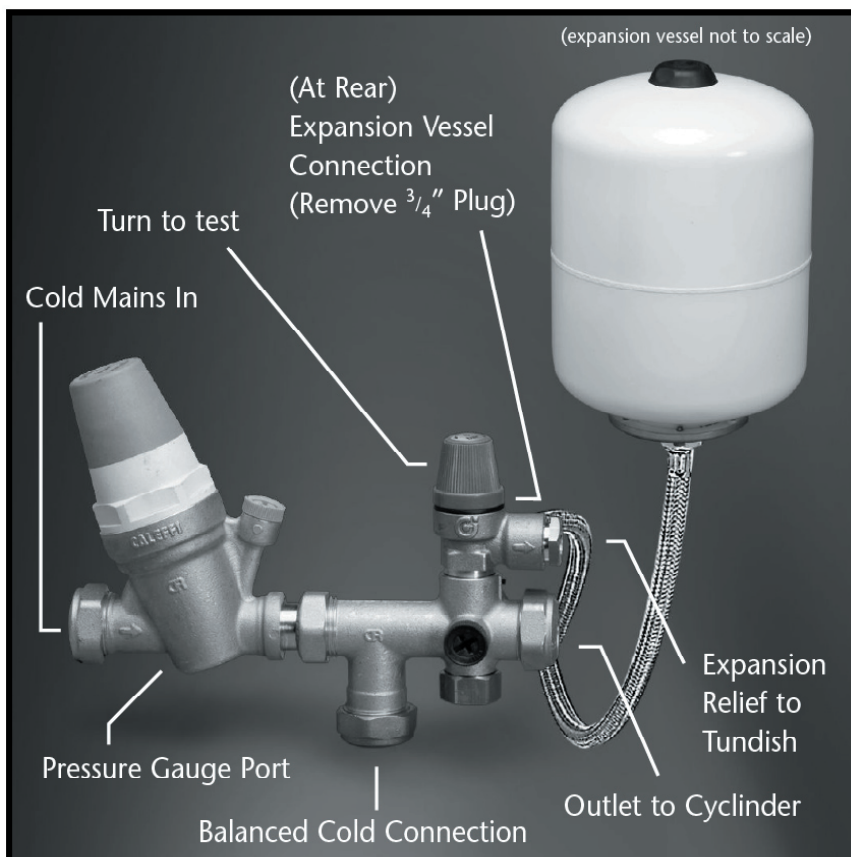

DISCHARGE ARRANGEMENT

Detailed discharge pipe installation requirement

The discharge pipework must be routed in accordance with part G3 of schedule 1 of the Building Regulations
The tundish should be vertical, located in the same space as the unvented hot water cylinder and be as close as possible and within 500mm of the safety device e.g. the temperature relief valve.

The discharge pipe from the Tundish should be:

- made of metal
- at least one pipe size larger than the nominal outlet size of the safety device (larger sizes may be required if the equivalent hydraulic resistance exceeds that of a straight pipe 9 metres long - refer to BS6700)
- terminate in a safe place where there is no risk to persons in the vicinity of the discharge and positioned safely from electrical devices
- have a vertical section of pipe at least 300 mm long below the Tundish before any elbows or bends in the pipework installed with a continuous fall
- visible at both the tundish and the final point of discharge or where this is not possible or practically difficult there should be clear visibility at one or the other of these locations.

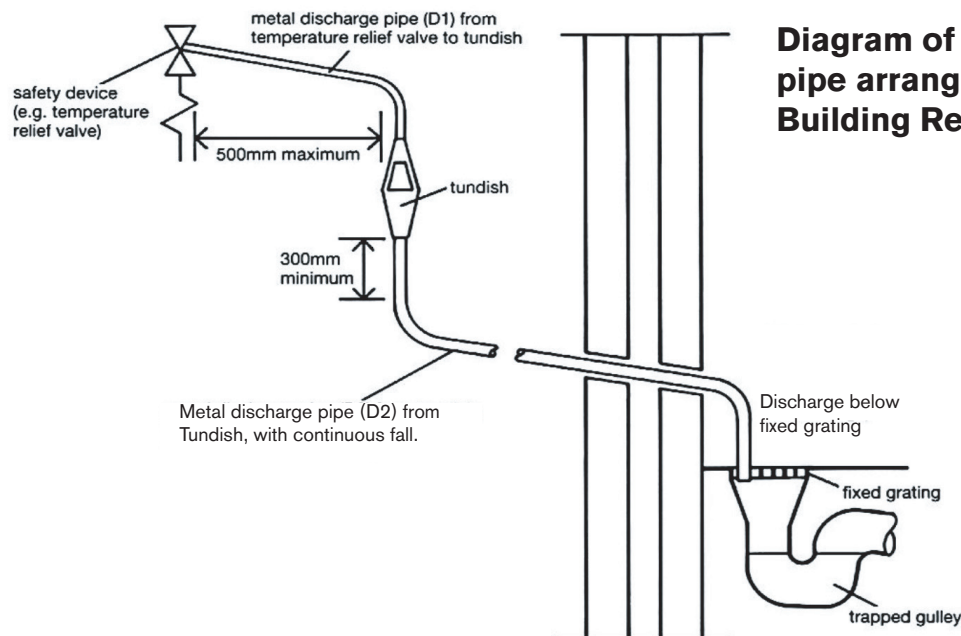

Diagram of a typical discharge pipe arrangement (extract from Building Regulation G3)

Note: The discharge will consist of scalding water and steam. Asphalt, roofing felt and non-metallic rainwater goods may be damaged by such discharges.

Note: It is not acceptable to discharge straight into a soil pipe.

Valve outlet size	Size of discharge pipework D1	Size of discharge pipework D2	Maximum length of straight pipe (no bends or elbows)	Deduct the figure below from the maximum length for each bend or elbow in the discharge pipe
		22mm	up to 9m	0.8m
G1/2	15mm	28mm	up to 18m	1.0m
		35mm	up to 27m	1.4m
		28mm	up to 9m	1.0m
<G3>/4	22mm	35mm	up to 18m	1.4m
		42mm	up to 27m	1.7m
		35mm	up to 9m	1.4m
G1	28mm	42mm	up to 18m	1.7m
		54mm	up to 27m	2.3m

COMMISSIONING SERVICING

FILLING

It is important that the inner cylinder is pressurized first, followed by the primary circuit.
Check the pressure in the DHW expansion vessel is 3 bar (44PSI), i.e the same as the setting of the pressure reducing valve.

Before filling, open the hot tap furthest away from the Greenstore cylinder to let air out. Open the cold main isolation valve and allow the unit to fill.

When water flows from the tap, allow it to run for a short while to flush through any dirt, swarf or flux residue.

Close the tap and open every other hot tap in turn to purge all remaining air.

The primary circuit can now be filled.

PRIMARY CIRCUIT - INDIRECT UNITS

Consult the Worcester Bosch commissioning instructions and fill the primary circuit.

STORAGE TEMPERATURE

In many applications the guidance on Legionella control and safe water delivery temperatures will require storing the water at 60-65°C, distributing at 50-55°C and using thermostatic mixing valves to control the final temperature.

SAFETY VALVE CHECKS

In order to check correct operation of both the expansion and temperature/pressure relief valves, fully open them allowing as much water as possible to flow through the tundish. Check that the discharge pipework is free from debris and is carrying the water away, to waste, efficiently. Release the valves and check that they reseal properly.

During heat-up of the cylinder there should have been no sign of water discharge from either the expansion relief valve or the temperature / pressure relief valve.

SPARE PARTS

Worcester carry the full range of spares listed below in stock. If you order before noon we will dispatch the same day for delivery the next day to most locations.

- 8 716 113 407 0 - Inlet control set (pressure reducing valve, strainer and expansion relief valve)
- 8 716 113 409 0 - Tundish
- 8 716 113 416 0 - 19 litre Expansion Vessel
- 8 716 113 418 0 - 24 litre Expansion Vessel
- 8 716 113 415 0 - Bracket, Expansion Vessel
- 8 716 113 414 0 - Hose, Expansion Vessel (3/4" M x 3/4" F)
- 8 716 113 439 0 - Allen Key
- 8 716 113 440 0 - Olive, Blanking 22mm
- 8 716 113 441 0 - Olive, Blanking 15mm
- 8 716 113 442 0 - Washer
- 8 716 113 498 0 - Solar High Limit Stat
- 8 716 113 473 0 - Temperature/Pressure relief valve
- 8 716 112 318 0 - Hot water sensor GT3

SERVICING

GENERAL

Servicing should only be carried out by competent installers and any spare parts used must be purchased from Worcester. NEVER bypass any safety devices or operate the unit without them being fully operational.

WARNING:

WATER DRAINED OFF MAY BE VERY HOT!

DRAINING

Isolate the unit from the cold mains.

Open a hot water tap at the lowest position in the building, to reduce the pressure.

Remove the mains water inlet connection. Attach a flexible hose to the connection on top of the cylinder, ensuring the hose reaches to a level well below the unit (The greater the difference in elevation, the greater the flow rate and the maximum amount of water drained from the cylinder).

Disconnect the hot water outlet.

Start the siphon effect, by either sucking or pumping the drain side of the flexible hose.

Allow the cylinder to drain completely.

FLUSHING THE TANK

To flush the cylinder, follow the procedure for draining. Connect a hose to the hot water outlet and then flush the system.

WARNING:

POSSIBLE SCALDING!

ANNUAL MAINTENANCE

Greenstore cylinders require an annual service in order to ensure safe working and optimum performance.

It is essential that the following checks are performed by a competent installer on an annual basis. This is done at the same time as the annual heat pump and solar service.

- 1) Twist the cap of the expansion relief valve on the inlet control set and allow water to flow for 5 seconds. Release and make sure it resets correctly. Repeat with the pressure / temperature relief valve.
In both cases check that the discharge pipework is carrying the water away adequately. If not check for blockages etc. and clear.
- 2) Check the pressure in the DHW expansion vessel is charged to 3 bar. Turn off the water supply to the unit and open a hot tap first.
- 3) Unscrew the head on the inlet control set and clean the mesh filter within.
- 4) The benchmark log book, in the back of this manual, must be updated at each service.

YOUR GUARANTEE MAY BE VOID WITHOUT PROOF OF ANNUAL SERVICING

THE GUARANTEE

The Greenstore cylinder carries a 2 year guarantee against faulty materials or manufacture provided that:

- It has been correctly installed as per this document and all the relevant standards, regulations and codes of practice in force at the time.
- It has not been modified in any way.
- It has not been misused, tampered with or subjected to neglect
- It has only been used for the storage of potable water.
- It has not been subjected to frost damage.

- The unit has been serviced annually
- The benchmark log book has been filled in after each annual service
- The guarantee provided starts from the date of commissioning
- Building Control notification is required

Please note that invoices for servicing may be requested to prove that the unit has been serviced annually.

All the components fitted to / or supplied with the Greenstore cylinder carry a 2 year guarantee.

180/280 LITRE CYLINDERS WITH SOLAR COIL

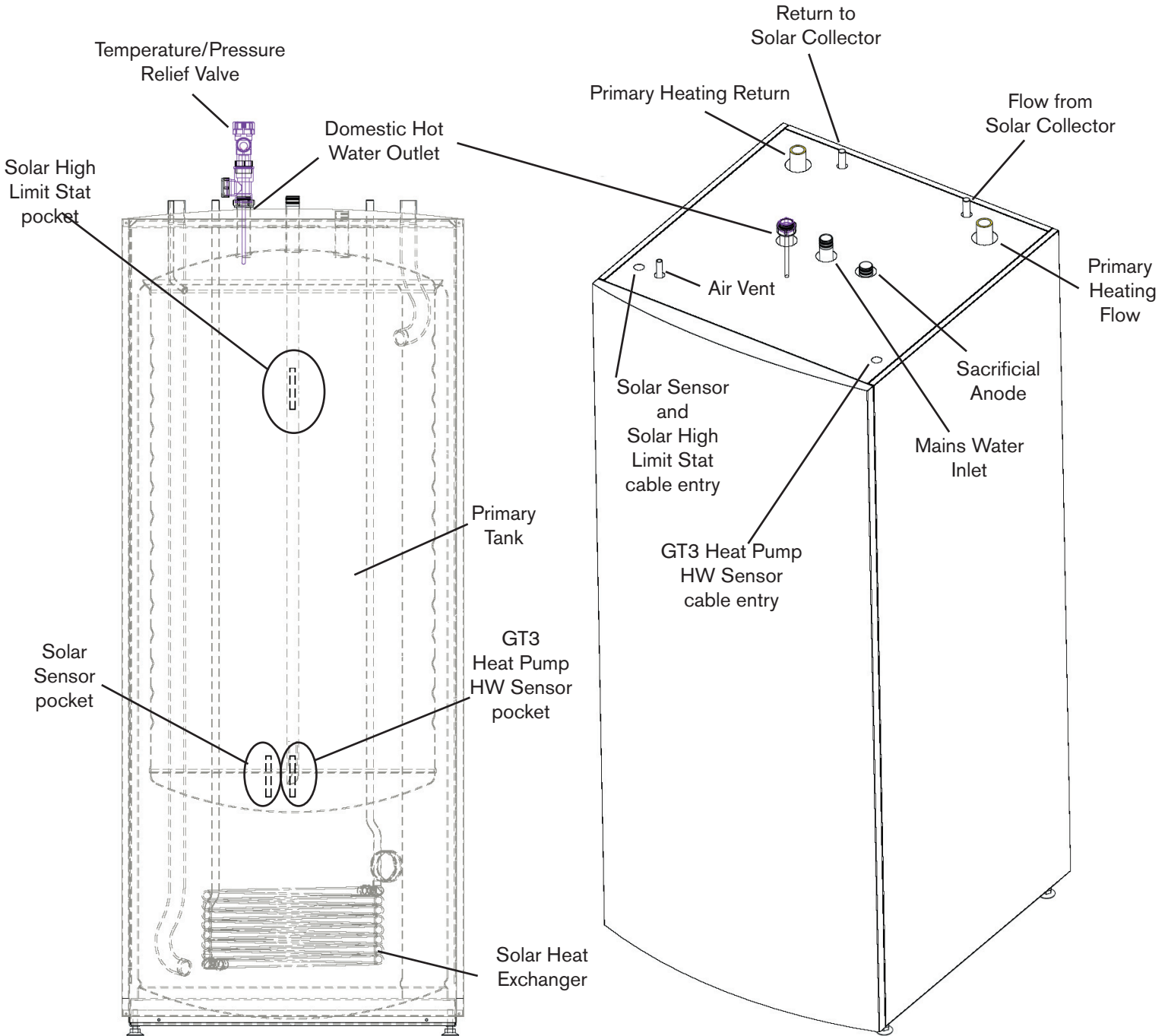

Connecting hot water sensor GT3

Before carrying out any electrical connections, ensure that the Heat Pump is isolated from the mains supply. Remove the Heat Pump front cover and route the sensor cable from the back of the Heat Pump, laying the sensor cable onto the cable tray. Connect the sensor to terminals GT3X on the terminal card.

Remove the cylinder front cover. Feed the sensor cable through the grommet of the right-hand cable entry, on top of the cylinder. Fully insert the sensor probe into the GT3 sensor pocket, as indicated on the diagram above. Replace the cylinder front cover.

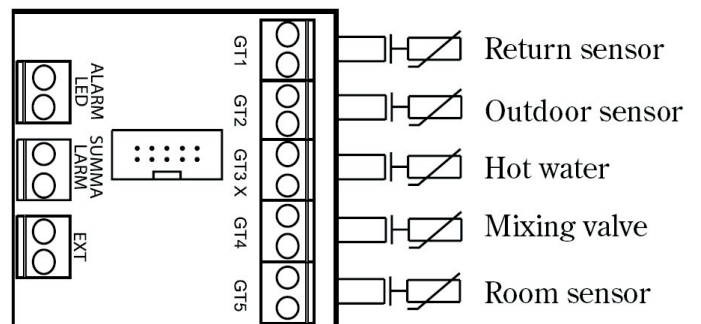

SPECIFICATION SUMMARY

This is based on a 9kW Heat Pump input

180 litre cylinder storage capacity

DHW side - 180 Litre

Primary side - 105 Litre

180 litre Cylinder heat up time

From 15°C to 60°C - 144 minutes

Reheat time

For 70% volume - 47 minutes

Heat loss time

For 60°C to 53.6°C - 24 hours

280 litre cylinder storage capacity

DHW side - 280 litre

Primary side - 180 litre

280 litre Cylinder heat up time

From 15°C to 60°C - 163 minutes

Reheat time

For 70% volume - 53 minutes

Heat loss time

For 60°C to 53.6°C - 24 hours

Materials

Shell - Stainless steel, inner - black carbon steel, outer

Coil - 15mm diameter copper

Greenstore cylinder is water tested to a pressure of 13 bar.

Insulation

Fire retardant mineral wool, nominal thickness 50mm.

Casework

Powder coated corrosion proof steel

Anode

Fitted (Aluminium)

Expansion Vessel

19 Litre size with 180 litre model

24 Litre size with 280 litre model

Control Settings

Pressure Reducing Valve	- 3 bar
Expansion Relief Valve	- 6 bar
Pressure and Temperature Relief Valve	- 7 bar / 95°C
Max inlet pressure (PRV)	- 16 bar
Operating pressure (primary side)	- 2.5 bar
Maximum operating pressure (DHW)	- 3.0 bar
Expansion vessel pressure charge	- 3.0 bar
Expansion relief valve setting	- 6.0 bar

PART No.	CAPACITY	HEIGHT	WIDTH	DEPTH	WEIGHT kg empty	WEIGHT kg full
7 716 180 017	180 L	1520	600	650	97	387
7 716 180 018	280 L	1700	695	695	136	596

All Dimensions are of the cased unit and are in mm.

Approvals

- KIWA Approved to the Water Regulations
- KIWA Approved to Building Regulations' G3 & L1

COMMISSIONING PROCEDURE INFORMATION

ENERGY SOURCE PRIMARY SETTINGS (INDIRECT HEATING ONLY)

IS THE PRIMARY A SEALED OR OPEN VENTED SYSTEM? SEALED OPEN

WHAT IS THE ENERGY SOURCE FLOW TEMPERATURE?

ALL MAINS PRESSURED SYSTEMS

WHAT IS INCOMING STATIC COLD WATER PRESSURE AT THE INLET TO THE PRESSURE REDUCING VALVE? bar

HAS A STRAINER (IF FITTED) BEEN CLEANED OF INSTALLATION DEBRIS? YES NO

HAS A WATER SCALE REDUCER BEEN FITTED? YES NO

WHAT TYPE OF SCALE REDUCER HAS BEEN FITTED

UNVENTED SYSTEMS ONLY

ARE COMBINED TEMPERATURE/PRESSURE RELIEF VALVE AND EXPANSION VALVE FITTED AND DISCHARGED TESTED? YES NO

IS PRIMARY ENERGY SOURCE CUT-OUT FITTED (NORMALLY 2 PORT VALVE)? YES NO

WHAT IS THE PRESSURE REDUCING VALVE SETTING (IF FITTED) bar

WHERE IS OPERATING PRESSURE REDUCING VALVE SITUATED

HAS THE EXPANSION VESSEL OR INTERNAL AIR SPACE BEEN CHECKED YES NO

WHAT IS THE HOT WATER TEMPERATURE AT THE NEAREST OUTLET °C

THERMAL STORES ONLY

WHAT IS THE OPERATING SETTING OF THE PRESSURE REDUCING VALVE (Where fitted)? bar

WHERE IS THE PRESSURE REDUCING VALVE SITUATED?

WHAT STORE TEMPERATURE IS ACHIEVABLE? °C

WHAT IS THE MAXIMUM HOT WATER TEMPERATURE? °C

WHAT IS THE MAXIMUM HOT WATER FLOW RATE AT MAXIMUM TEMPERATURE? lts/min

ALL PRODUCTS

DOES THE HOT WATER SYSTEM COMPLY WITH THE APPROPRIATE BUILDING REGULATIONS? YES

HAS THE SYSTEM BEEN INSTALLED AND COMMISSIONED IN ACCORDANCE WITH THE MANUFACTURER'S INSTRUCTIONS? YES

HAVE YOU DEMONSTRATED THE OPERATION OF THE SYSTEM CONTROLS TO THE CUSTOMER? YES

HAVE YOU LEFT ALL THE MANUFACTURER'S LITERATURE WITH THE CUSTOMER? YES

COMPETENT PERSON'S SIGNATURE

CUSTOMER'S SIGNATURE

(To confirm demonstrations of equipment and receipt of appliance instructions)

SERVICE INTERVAL RECORD

It is recommended that your heating system is serviced regularly and that your service engineer completes the appropriate Service Interval Record below.

SERVICE PROVIDER

Before completing the appropriate Service Interval Record below, please ensure you have carried out the service as described in the manufacturer's instructions and in compliance with The Safety Regulations.

Always use the appliance manufacturer's specified spare parts.

SERVICE 1 DATE: _____
ENGINEER NAME _____
COMPANY NAME _____
TEL No. _____
CORGI ID SERIAL No. _____
COMMENTS _____
SIGNATURE _____

SERVICE 2 DATE: _____
ENGINEER NAME _____
COMPANY NAME _____
TEL No. _____
CORGI ID SERIAL No. _____
COMMENTS _____
SIGNATURE _____

SERVICE 3 DATE: _____
ENGINEER NAME _____
COMPANY NAME _____
TEL No. _____
CORGI ID SERIAL No. _____
COMMENTS _____
SIGNATURE _____

SERVICE 4 DATE: _____
ENGINEER NAME _____
COMPANY NAME _____
TEL No. _____
CORGI ID SERIAL No. _____
COMMENTS _____
SIGNATURE _____

SERVICE 5 DATE: _____
ENGINEER NAME _____
COMPANY NAME _____
TEL No. _____
CORGI ID SERIAL No. _____
COMMENTS _____
SIGNATURE _____

SERVICE 6 DATE: _____
ENGINEER NAME _____
COMPANY NAME _____
TEL No. _____
CORGI ID SERIAL No. _____
COMMENTS _____
SIGNATURE _____

SERVICE 7 DATE: _____
ENGINEER NAME _____
COMPANY NAME _____
TEL No. _____
CORGI ID SERIAL No. _____
COMMENTS _____
SIGNATURE _____

SERVICE 8 DATE: _____
ENGINEER NAME _____
COMPANY NAME _____
TEL No. _____
CORGI ID SERIAL No. _____
COMMENTS _____
SIGNATURE _____

When all the above service entries have been completed, please contact your Service Engineer for an additional service interval record sheet

NOTES

NOTES

EXCELLENCE COMES AS STANDARD
Worcester, Bosch Group,
Cotswold Way, Warndon, Worcester WR4 9SW
Tel. 01905 754624 Fax. 01905 754619

Worcester, Bosch Group is a brand of
BBT Thermotechnology UK Ltd.

www.worcester-bosch.co.uk

User and Installation Instructions Greenstore Cylinder
-Solar Compatible

8 716 113 377b 2007/01 EN

CONTACT INFORMATION

WORCESTER, BOSCH GROUP:

TECHNICAL: 08705 266241

SERVICE: 08457 256206

SPARES: 01905 752576

LITERATURE: 01905 752556

TRAINING: 01905 752526

SALES: 01905 752640

WEBSITE: www.worcester-bosch.co.uk



WORCESTER
Bosch Group